

wise

Electric Curtain Catalog





Motorized curtain

creating perfect household

MOTORIZED CURTAIN SOLUTIONS

In 2008 first manual & automated motor all-in-one was born

Technology revolution from the end of 2008, At that time the industry adopt electronic clutch and the external transformer . WISE is develop the mechanical clutch to integrated with the built-in receivers and transformers. Now the industry including import brands also refer to this technology.

from 2009 Technology innovation as hand pull then curtain start to move , automatic memory, comprehensive support for smart home interface,such as 232, 485, 9 kinds of dry touch switch mode.



N09



3 DIFFERENT CHARACTERISTICS

motor on hidden inhead type mounting design

Motor can Upward installed or downward installed, also can be hidden in the smallpox ceiling based on different requirement

FSK FM technology, top 868MHZ for anti-jamming military

Strong anti-interference ability, high receiver sensitivity, stable center frequency, convenient setting features.

all-metal type shaft

the unique metal shaft design, long time working life, does not slip.



Curtain



Cable



Radio



Center control

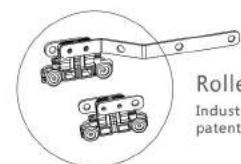

Roller carrier
Industry pioneering patent technology



N18 Curtain Motor

Comfortable with 25DB silent working



N09 Curtain Motor

N09、N18 Motorized Curtain Function Statement

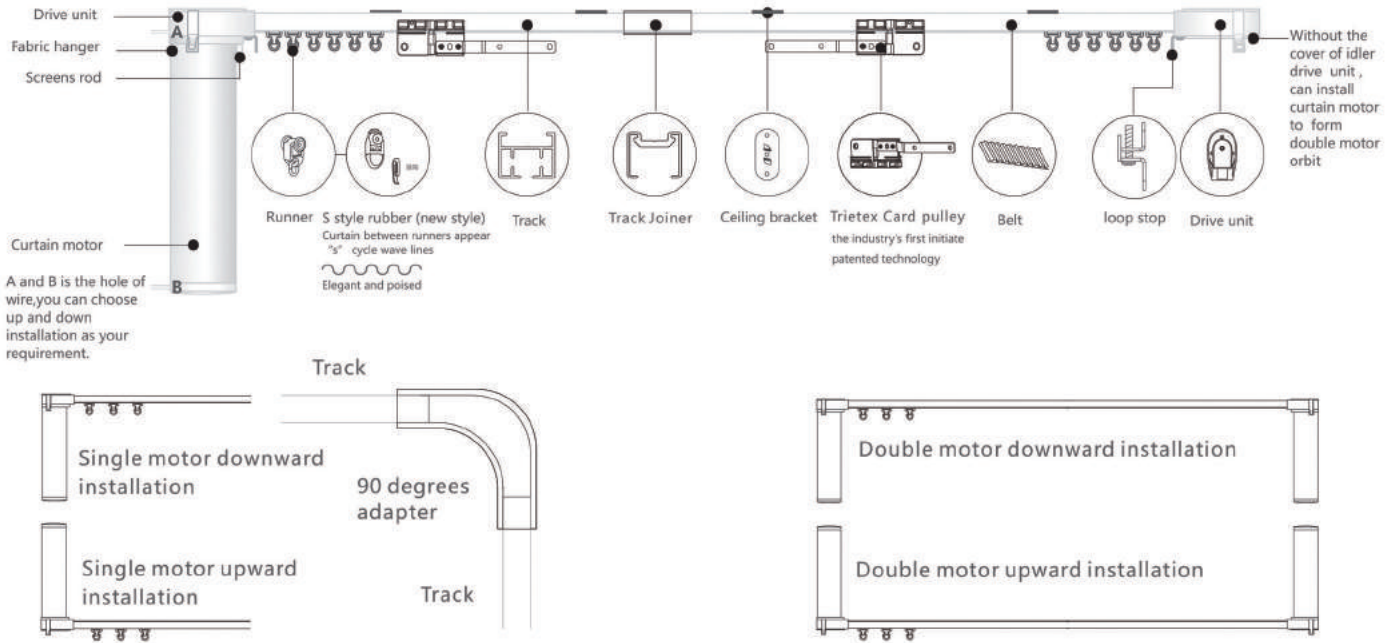

Product Features :

1. Motor has specific memory function, automatic stop sensor for the travel (no need to set travel in advance).
2. With hand-operated & motor operated mode, both are easy to operate.
3. One-stop design, built-in power + receiver, with external interface (2 x RJ11 interface)
4. Motor can start by itself by pulling just 15cm of the fabric (no need the transmitter).
5. The complete set of system with the best material, with high quality coating inside out of the track, belt with steel wire, and cloth on both side, all the hardware accessories are made of stainless steel.
6. Group control, central control .
7. "S style rope runner combination "patent design, easy to assemble and disassemble, pretty appearance, can be designed to a dynamic "S" style movable curtain.
8. Strong power, low noise design, different bending track can be customized.

Wiring method of N09 terminal switch

(Note: Please use the rebound or light touch switch)

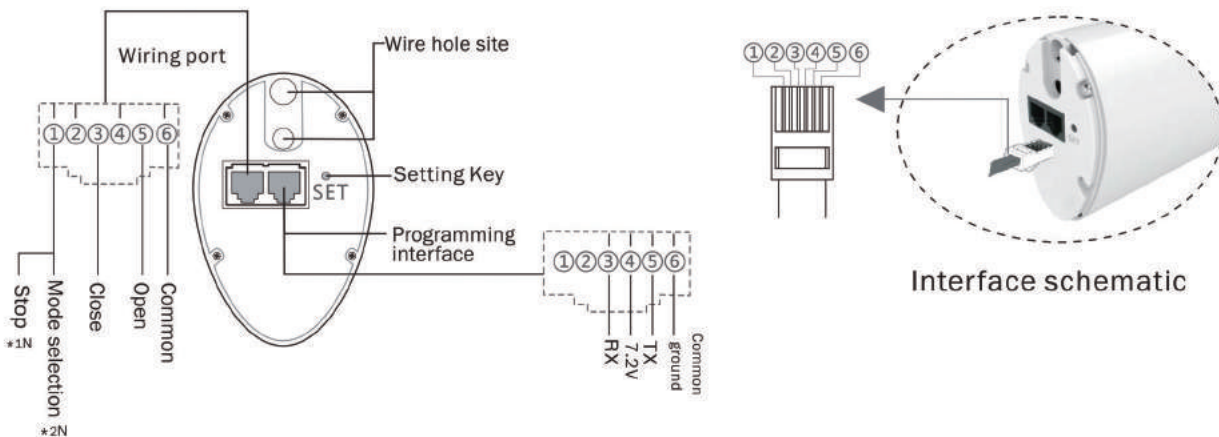

N18, N09 Motorized Curtain Function Statement

Low voltage mode selection

⚠ The default is the first switch.

Mode one:

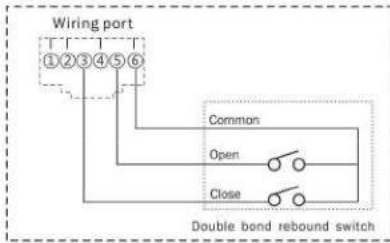

Mode two:

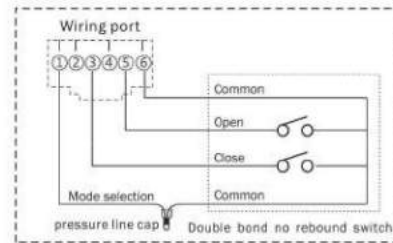

AC power switch installation wiring diagram

- ⚠**
- ① Strong current control distance more than 60m, the need for special custom.
 - ② Zero line and Fire wire can not be reversed. If there is a spare line after wiring, please use pressure line cap to do well insulation.

AC power switch double-key mode five-wire connection method:



AC power switch double-key mode four-wire connection method:

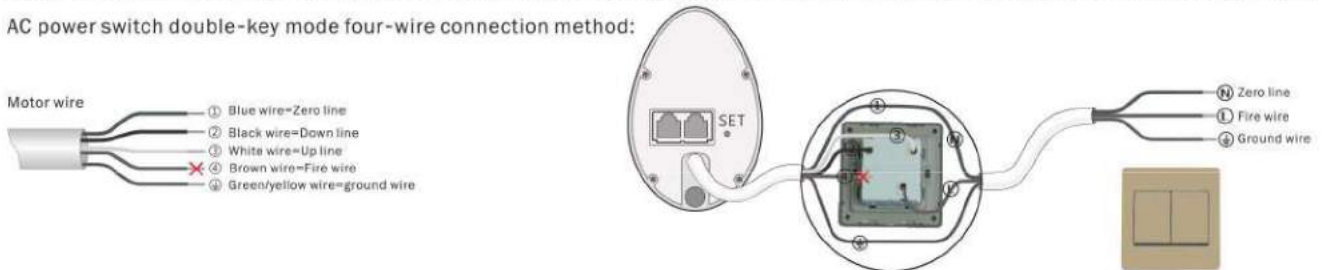

AC power switch hotel mode connection method:



Three-wire conventional wiring method:

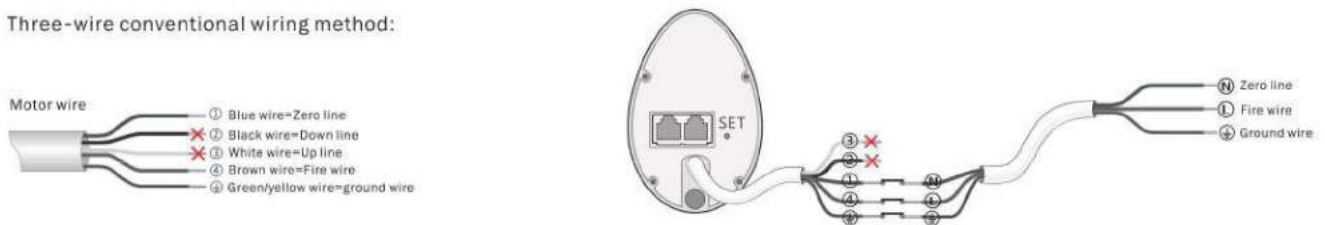

N18 Curtain Motor



- 
Silent
- 
Curtain
- 
Cable
- 
Radio
- 
Center control

N18-4A5-2

Unit : mm

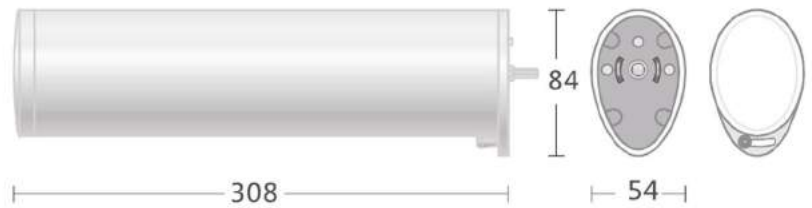

Item NO.	5 wires strong current	Lithium Battery	485/232	WiFi Control	Dry contact	Automatic Limit	Hand pull when power off	Stop by resistance	Soft start and Soft stop	Curtain rebound	Adjustable speed	Hand pull start
N30045	●			●	●	●	●	●	●	●	●	●

Item NO.	Item	Torque (N.m)	Power (w)	Speed (cm/s)	Rated revolution (rpm)	Working voltage (v)	Receiving frequency (MHz)	Motor length (mm)	Motor weight (kg)
N30045	N18-4A5-2 curtain motor	2	48	10-20	80-120	AC100-240	868	308	0.86

N09 Curtain Motor (inbuilt receiver)



Model characteristics	Soft start and stop	Dry contact	Stroke memory	Inbuilt receiver + transformer	Manual mode	Motorized mode	Pulling start the motor function
N30011		•	•	•	•	•	•

Item NO	Item	Torque (N.m)	Power (w)	Speed (cm/s)	Working voltage (v)	Frequency (Hz)	Rated r evolution (rpm)	Straight rail splicing maximum length (m)	Motor weight (kg)
N30011	N09-EL-2Curtain Motor	2	80	20	200-230	50/60	110	12	1.4



Installation Instruction

Unit:mm

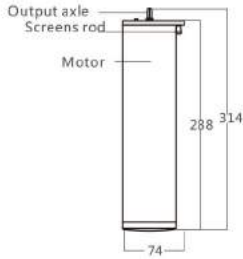

Motor size

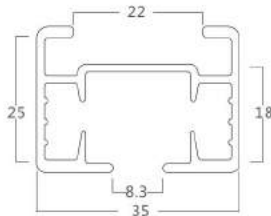

Track section

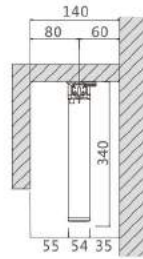

Single straight track installation

(Minimum space between)

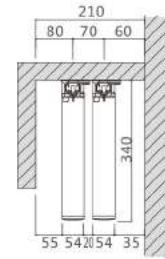

Double straight track installation

(Minimum space between)

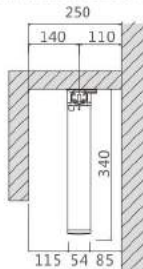

Single curved track installation

(Minimum space between)

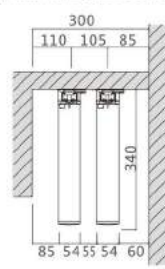

Double curved track installation

(Minimum space between)

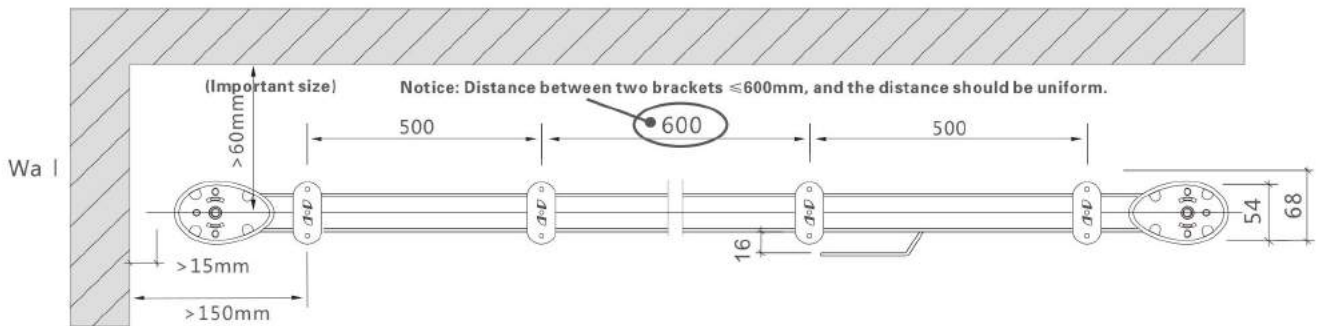

Ceiling

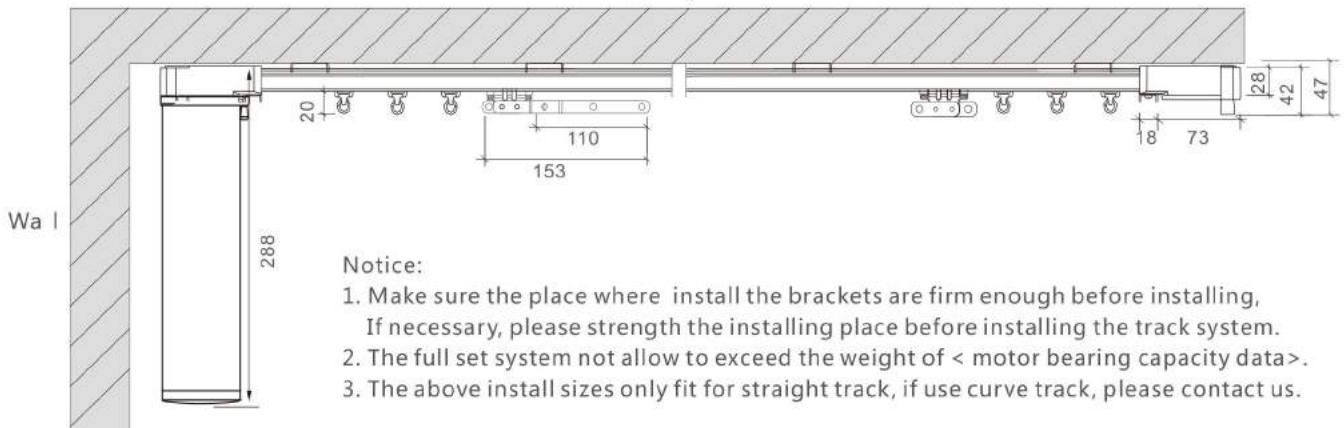

Notice:

1. Make sure the place where install the brackets are firm enough before installing, If necessary, please strength the installing place before installing the track system.
2. The full set system not allow to exceed the weight of < motor bearing capacity data >.
3. The above install sizes only fit for straight track, if use curve track, please contact us.

Bearing Capacity Data

Unit:mm

Installation drawings

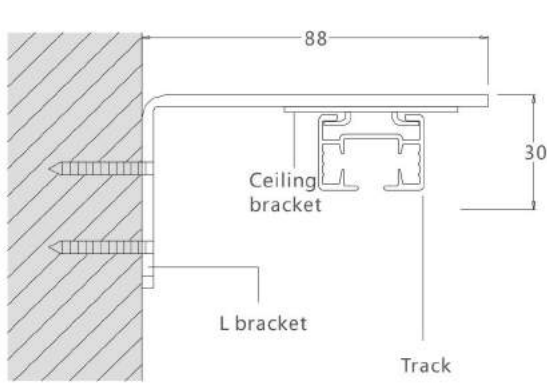

Side installation

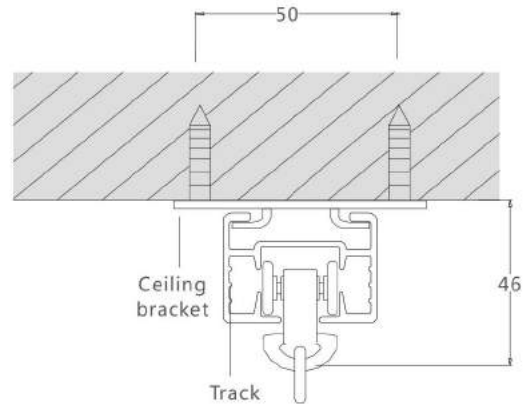

Top installation

Single motor

Unit:KG

Fabric length \ Track style	Track style 1	Track style 2	Track style 3	Track style 4	Track style 5	Track style 6	Track style 7	Track style 8	Track style 9
			R500	R500	R500	R500	R500	R3000	R3000
4m	60	50	45	40	35	30	31	21	
8m	55	45	40	35	30	25	21	16	
12m	50	40	35	30	25	20			

Double motor

Fabric length \ Track style	Track style 1	Track style 2	Track style 3	Track style 4	Track style 5	Track style 6	Track style 7	Track style 8	Track style 9
			R300	R300	R300	R300	R300	R3000	R3000
12m	90	70	60	50	40	30	30	23	

Remark: Double open Single open



Fabric weight = fabric weight (kg/m²) × fabric area covered (m²) × wrinkles rate

Remark:

- Shown in the table above the maximum bearing of the single and double motor to suit the different tracks as we list above. when calculate the maximum bearing of the motor ,it is should take the fabric wrinkles rate into consideration. So we recommend the following formula to calculate the fabric weight: Fabric weight = fabric weight kg/m² X fabric area covered m² X wrinkles rate
- The list of the motor maximum bearing don't take the extra motivation between fabric, track and curtain box into consideration.



MotorizedRoller Blind

creating perfect household

MOTORIZED ROLLER BLIND SOLUTIONS

WISE electric roller blind is a full range of pipe carriers, Italian design, German standards, the representative of China. Hidden antenna, military grade 868 frequency. Low noise double-toothed gearbox on 100% imported materials, the capsule silencing technology.

Motor selection reference formula

Weight capacity(kg)=rated torque(N.m)÷tube radius(m)÷10

Torque(N.m)= tube radius(mm) ×Weight capacity(kg) ÷100





K45 Tubular Motor

international design ,
learn from European industry

K45 Tubular Motor



3 HUMANIZED DESIGN

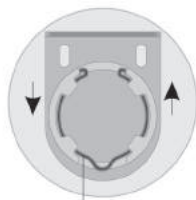

snap ring

Through the installation and dismantling of the snap ring ,can dismantle faster and safer without using the screw.

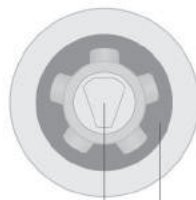

Motor output shaft

Adapt wheel

One-button design, make the adapt wheel easy and fast to dismantle and install.

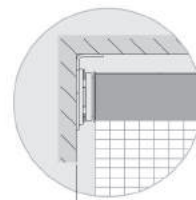

Wall

Fabric edge

Shortest design the distance between the fabric edge and wall, only 22mm, greatly improve the overall effect of the shade.

The tubular motor install directly inside the Al alloy tube ,this improve the safety and reliability effectively. Through the use of sound insulation technology , have improved the whole quality of the use of the motor system, can better meet the needs of users. Due to a variety of functions of comprehensiveness and fabric choice of diversification, with the other indoor tracery combination, it is popular with more and more customers nowadays .

Interpretation of item

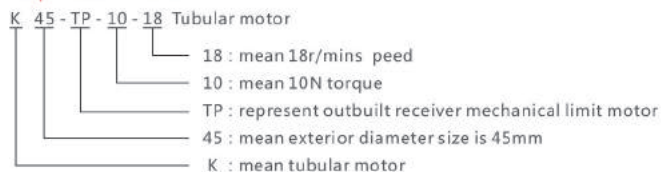

Item NO	Item	Rated torque (N.m)	Rated speed (rpm)	Power (w)	input voltage (v)	frequency (Hz)	Noise index (db)	Duration (min)	protection level (IP)	Length (mm)
D10312	K45-TP-10-18 Tubular motor	10	18	75	200-230	50/60	≤45	4	IP44	549

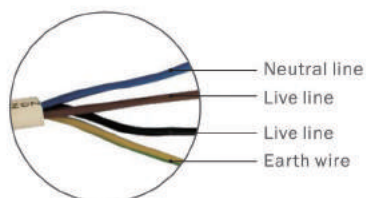



K45 Tubular motor

European process manufacturing

6 ADVANTAGE FUNCTION

use low-noise double-toothed gearbox

The output shaft and motor head use unique plum-shaped design, DuPont nylon, never slip;

Mute operation, lower 45 decibels

Precise stroke limit system , Precision can reach $\pm 2^{\circ}$

FSK FM technology, top 868MHZ for anti-jamming military, built-in antenna design.

Stable brake system



Interpretation of item

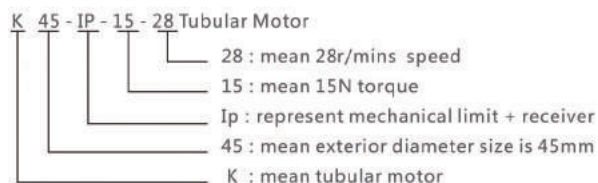

Roller blind



Cable



Radio



Center control

Item NO.	Item	Rated torque (N.m)	Rated speed (rpm)	Power (w)	Input voltage (v)	Frequency (Hz)	Noise index (db)	Protection level (IP)	Control method	Length (mm)
D10331	K45-IP-20-18 Tubular Motor	20	18	150	AC220	50	≤45	IP44	RF 868	649

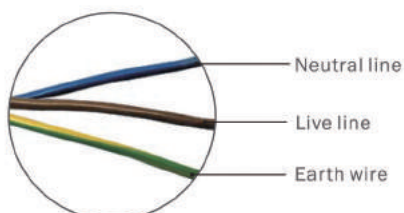

25mm Tubular Motor: Lithium Battery +Radio Control+ Electric Limit

Synchronous control, Third limit



Roller blind



zebra blinds



K 25 - 4E - 1.6 - 26 Tubular motor

- 26 : mean 26r/mins speed
- 1.6 : mean 1.6N torque
- 4E : electrical limit+receiver+battery + Low power consumption
- 25 : mean exterior diameter size is 25mm
- K : mean Tubular motor

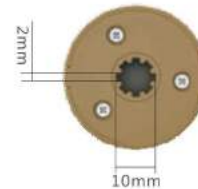
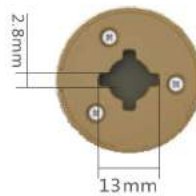

Item NO.	Item	Rated torque (N.m)	Rated speed (rpm)	Power (w)	Input voltage (v)	Control method	Noise index (db)	Protection level (IP)	Length (mm)
D10369	K25-4E-1.1-26 Tubular motor S (pair with solar panel D22600)	1.1	20/30	13	DC 9	RF868	30-40	IP44	395

Aluminium pipe: $\Phi 38$ groove pipe

A20 Solar Panel



Solar panel angle can be adjusted freely

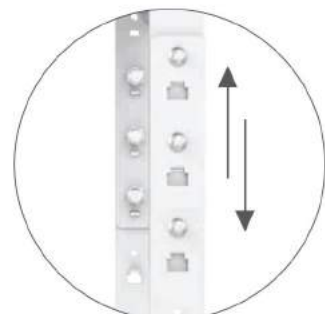

Solar panel height can be adjusted freely

Item NO.	Item	Power (w)	input voltage (v)	Length (mm)
D22600	A20-12 solar panel	1.8	12	210x65

Motorized Roller Blind



Motorized Roller Blind use tubular motor, has the multifunction of UV resistance, environment-friendly and energy-saving, sound-proofing and anti noise, beautifythe environment, ventilate and lighting, saving the space and so on. Operate easily, you just need press the remote control system, the roller blind can work under the quiet and stable condition. Due to the perfect multifunction and the diversity of choice for the fabrics, combine with other indoor window decorations, roller blind is very popular by more and more people, and widely used in star hotel, office building, exhibition center, villa and apartment building and so on.

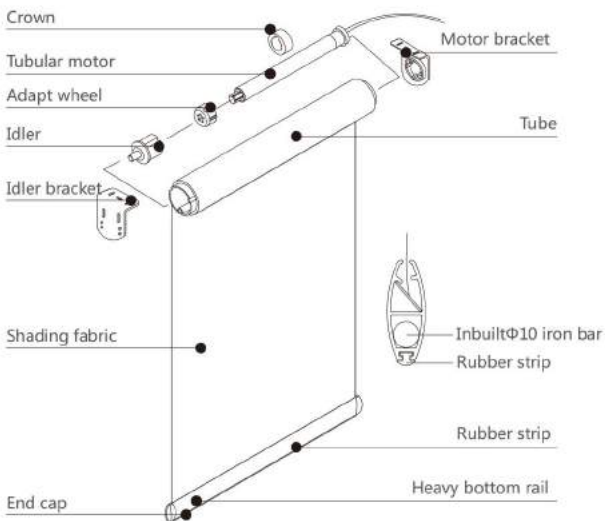
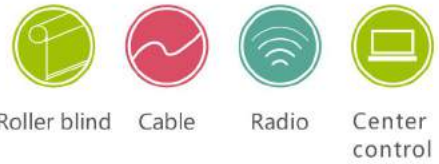

Motorized Roller Blind structural drawing

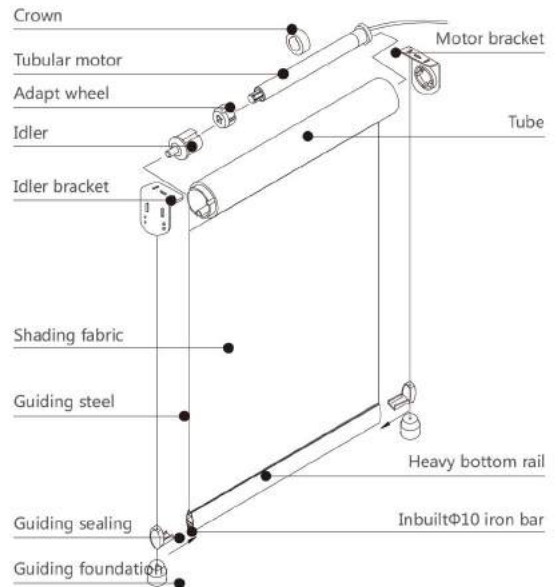

Motorized Roller Blind (Guiding steel) structural drawing

50mm Wooden Venetian Blind



50mm Wooden Venetian Blind is widely used in offices, hotels, study room, meeting room partition, bathroom or toilet partition and so on. Using 40 Tubular Motor, it has built-in brake and rotatory limit adjustment, make the noise very low and the limit control very precise. The biggest size for single set of blind can be width 4m X height 5.5m. The blade can be turned upside down and retractable freely, and its width is 25mm and 50mm, you can choose different materials according to your request, such as AL blade, bamboo blade, wooden blade and so on.

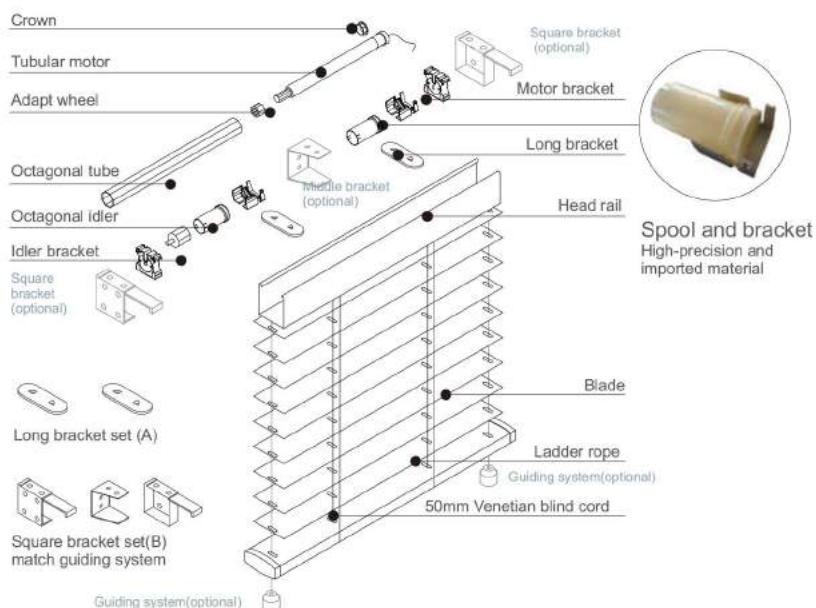

50mm Wooden Venetian Blind structural drawing



50mm flat roman blind

Fcs Folding Skylight Shade

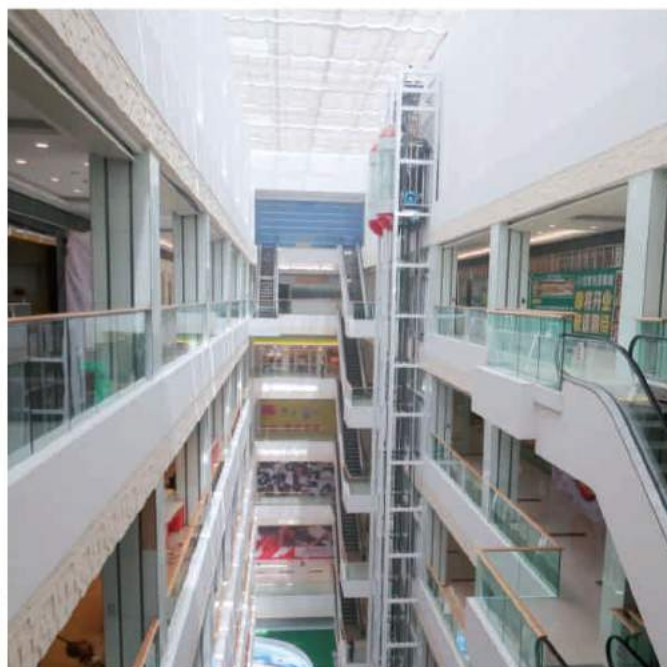

FCS Folding Skylight Shade system use the technology of fabric be folded and pulled as a single cycle, it includes drive system, fabric and remote control system. Drive system has one side as dynamic port, using tubular motor drive the tube and spool turning. Then make the steel wire pulling and loosing, the other side is spring system, the steel wire change directions by pulley. Then make the both side of the steel wire fasten on the rope winder and keep it tight state. When the size of the width or length for the FCS shade is too big, there need to add pulling steel wire or the tracks guiding system. FCS system has little tensile force. So there has no requirements on the fabric, and it's widely used in many places.



FCS folding skylight shade



Cable



Radio



Center control

Installation requirement :

it can install at any place in the middle, the width for one blind is 0.7-3.5m, the length is $\leq 10m$, the single area is $\leq 35m^2$. There must add a intermediate bracket when drive two or three blinds with one motor, and there must add a universal joint when the axes for the driving is not in a line, and the maximum line angle is 130° . You can choose the different tubular motor according to the width and the length of the FCS blind.

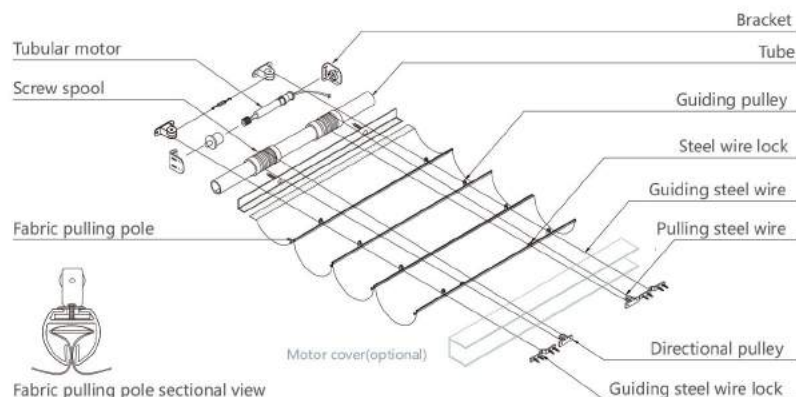

FCS Folding Skylight Shade (Steel wire guiding)

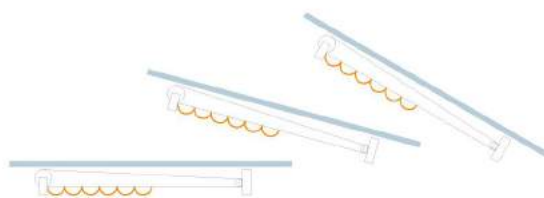

FCS Folding Skylight Shade (Installation method)



FSS Skylight Shade system uses single motor with elastic technology mechanism, which is designed in level and slant or curved glass skylight system. It's mainly made up of tubular motor and elastic tensile force system, one side uses tubular motor and the other side uses strong spring, making the fabric keep flat and stretching. The power produced by the tubular motor, through the tensile force produced by the motor rotating with the spring system. Then the steel wire pulls the fabric open and close. When positive direction rotating, the motor overcomes the resistance of the spring system and pulls back the fabric. When opposite rotating, the spring system pulls back the fabric.

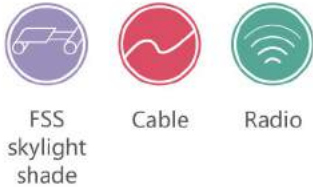

Installation requirement :

It can be installed at any place in the middle, the width for one blind is 0.7-3.0m, the length is $\leq 9m$, the single area is $\leq 27m^2$. There must be an intermediate bracket when driving two or three blinds with one motor, and there must be a fabric pulling pole when the axes for the driving are not in a line, you can choose the different tubular motor according to the width and the length of the FCS blind.

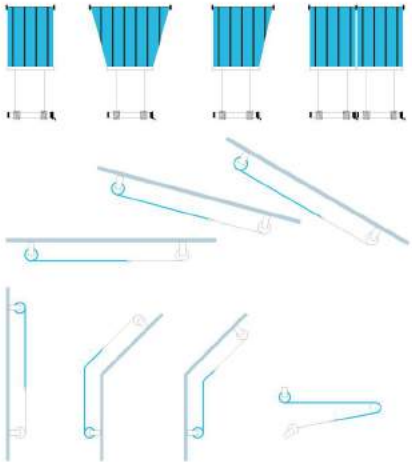
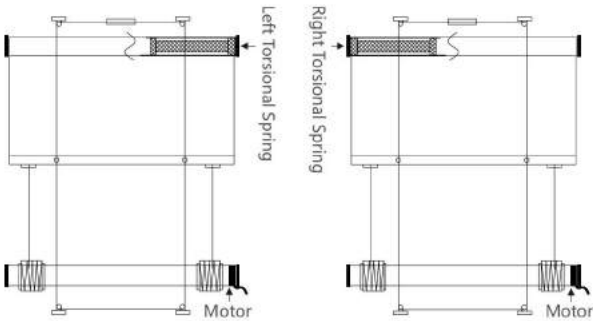

FSS skylight (installation method)

Fss Skylight Torsional Spring

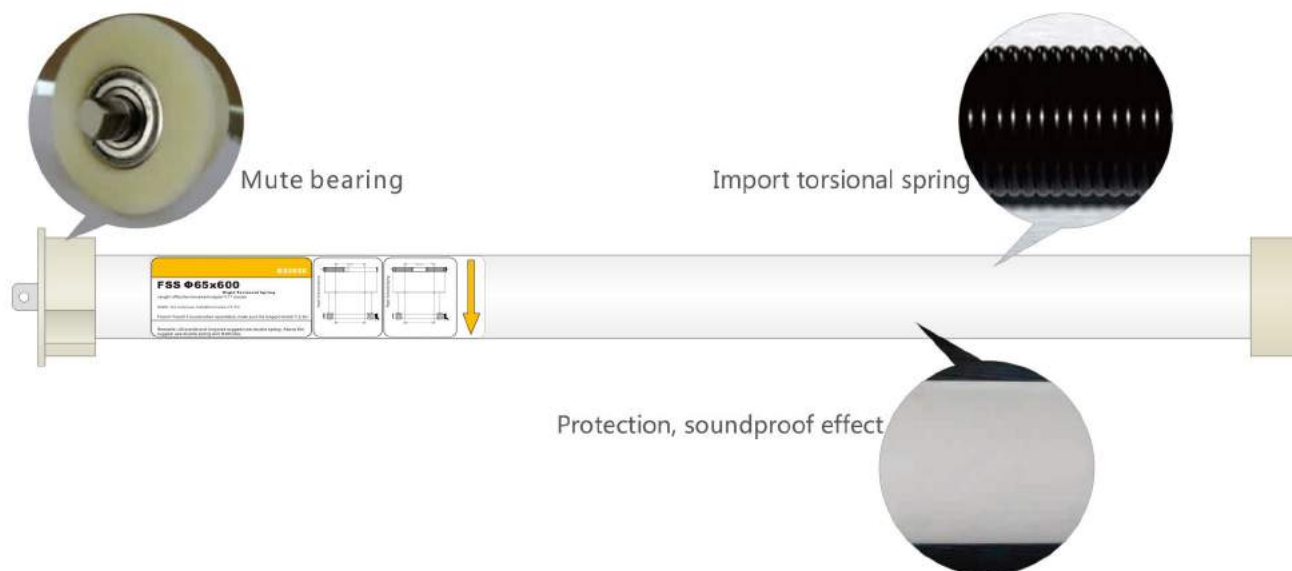

Torsional Spring can transport the power by the friction which is produced by its torsion. It's the most important part in FSS skylight system. It's performance and stability are very pivotal for the whole system. The import torsional spring has so excellent comprehensive performance to become the preferred products in FSS skylight system. It has good elasticity with high purity and very uniform texture, make itself has high yield strength when working. Under the safe range, it will not have permanent deformation after the load is taken off. The import spring has the features of heatproof, low temperature resistance, oxidation resisting, and corrosion resisting. It's high fatigue strength with enough tenacity and plasticity make the spring have long service life, will not be easily broken during it's working.

FSS torsional spring reference

	FSS $\Phi 65 \times 600$ torsional spring	FSS $\Phi 65 \times 800$ torsional spring	FSS $\Phi 65 \times 1000$ torsional spring	FSS $\Phi 65 \times 1300$ torsional spring
(single spring)	Length: effective movement region ≤ 17 rounds	Length: effective movement region ≤ 22 rounds	Length: effective movement region ≤ 26 rounds	Length: effective movement region ≤ 32 rounds
	Width: the minimum installment size $\geq 0.7m$	Width: the minimum installment size $\geq 0.9m$	Width: the minimum installment size $\geq 1.1m$	Width: the minimum installment size $\geq 1.4m$
	Preroll: Preroll 6 rounds when assembled, make sure the longest stretch $\leq 2.5m$	Preroll: Preroll 6 rounds when assembled, make sure the longest stretch $\leq 3.5m$	Preroll: Preroll 6 rounds when assembled, make sure the longest stretch $\leq 4.5m$	Preroll: Preroll 6 rounds when assembled, make sure the longest stretch $\leq 6m$
	FSS $\Phi 90 \times 600$ torsional spring	FSS $\Phi 90 \times 800$ torsional spring	FSS $\Phi 90 \times 1000$ torsional spring	FSS $\Phi 90 \times 1300$ torsional spring
Length: effective movement region ≤ 17 rounds	Length: effective movement region ≤ 22 rounds	Length: effective movement region ≤ 26 rounds	Length: effective movement region ≤ 32 rounds	
Width: the minimum installment size $\geq 0.7m$	Width: the minimum installment size $\geq 0.9m$	Width: the minimum installment size $\geq 1.1m$	Width: the minimum installment size $\geq 1.4m$	
Preroll: Preroll 6 rounds when assembled, make sure the longest stretch $\leq 3.3m$	Preroll: Preroll 6 rounds when assembled, make sure the longest stretch $\leq 4.7m$	Preroll: Preroll 6 rounds when assembled, make sure the longest stretch $\leq 5.7m$	Preroll: Preroll 6 rounds when assembled, make sure the longest stretch $\leq 8m$	
(double spring)	FSS $\Phi 65 \times 600$ torsional spring	FSS $\Phi 65 \times 800$ torsional spring	FSS $\Phi 65 \times 1000$ torsional spring	FSS $\Phi 65 \times 1300$ torsional spring
	Length: effective movement region ≤ 17 rounds	Length: effective movement region ≤ 22 rounds	Length: effective movement region ≤ 26 rounds	Length: effective movement region ≤ 32 rounds
	Width: the minimum installment size $\geq 1.3m$	Width: the minimum installment size $\geq 1.7m$	Width: the minimum installment size $\geq 2.1m$	Width: the minimum installment size $\geq 2.7m$
	Preroll: Preroll 6 rounds when assembled, make sure the longest stretch $\leq 3m$	Preroll: Preroll 6 rounds when assembled, make sure the longest stretch $\leq 4m$	Preroll: Preroll 6 rounds when assembled, make sure the longest stretch $\leq 5m$	Preroll: Preroll 6 rounds when assembled, make sure the longest stretch $\leq 6.5m$
FSS $\Phi 90 \times 600$ torsional spring	FSS $\Phi 90 \times 800$ torsional spring	FSS $\Phi 90 \times 1000$ torsional spring	FSS $\Phi 90 \times 1300$ torsional spring	
Length: effective movement region ≤ 17 rounds	Length: effective movement region ≤ 22 rounds	Length: effective movement region ≤ 26 rounds	Length: effective movement region ≤ 32 rounds	
Width: the minimum installment size $\geq 1.3m$	Width: the minimum installment size $\geq 1.7m$	Width: the minimum installment size $\geq 2.1m$	Width: the minimum installment size $\geq 2.7m$	
Preroll: Preroll 6 rounds when assembled, make sure the longest stretch $\leq 3.8m$	Preroll: Preroll 6 rounds when assembled, make sure the longest stretch $\leq 5.3m$	Preroll: Preroll 6 rounds when assembled, make sure the longest stretch $\leq 6.3m$	Preroll: Preroll 6 rounds when assembled, make sure the longest stretch $\leq 8.7m$	

Remarks: ultra wide and long curtain please use double spring. Above 6 meters please use double spring and $\Phi 90$ tube.

Skylight Shade Motor



Skylight Shade system use the technology of fabric be folded and pulled as a single cycle, it includes drive system, fabric and remote control system. Drive system has one side as dynamic port, using tubular motor drive the tube and spool turning. Then make the steel wire pulling and loosing, the other side is spring system, the steel wire change directions by pulley.



Cable



Radio



Center control

Installation requirement :

it can install at any place in the middle, the width for one blind is 0.7-3.5m, the length is $\leq 10m$, the single area is $\leq 35m^2$. There must add a intermediate bracket when drive two or three blinds with one motor, and there must add a universal joint when the axes for the driving is not in a line, and the maximum line angle is 130° . You can choose the different tubular motor according to the width and the length of the FCS blind.

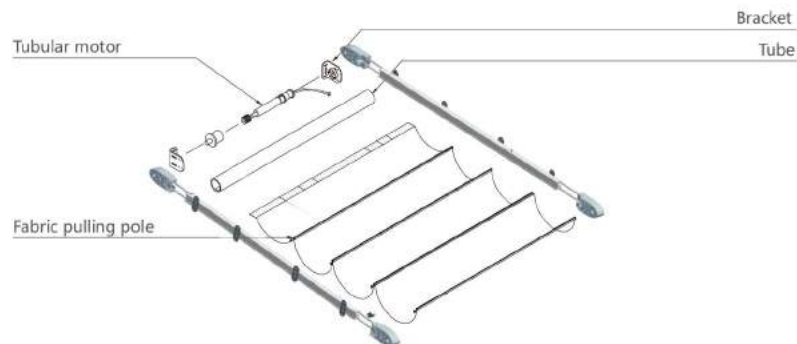

Skylight Shade Motor



Skylight Shade system use the technology of fabric be folded and pulled as a single cycle, it includes drive system, fabric and remote control system. Drive system has one side as dynamic port, using tubular motor drive the tube and spool turning. Then make the steel wire pulling and loosing, the other side is spring system, the steel wire change directions by pulley.



Cable



Radio



Center control

Installation requirement :

it can install at any place in the middle, the width for one blind is 0.7-3.5m, the length is $\leq 10m$, the single area is $\leq 35m^2$. There must add a intermediate bracket when drive two or three blinds with one motor, and there must add a universal joint when the axes for the driving is not in a line, and the maximum line angle is 130° . You can choose the different tubular motor according to the width and the length of the FCS blind.

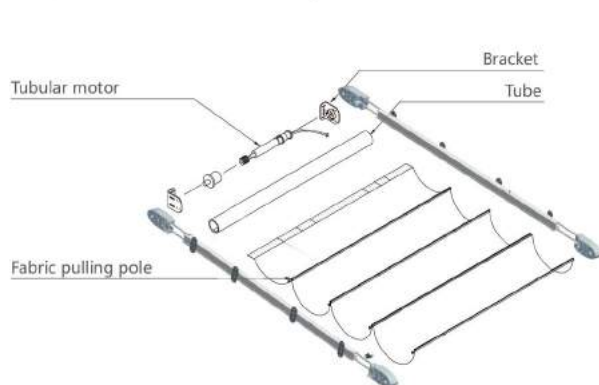

Skylight Shade

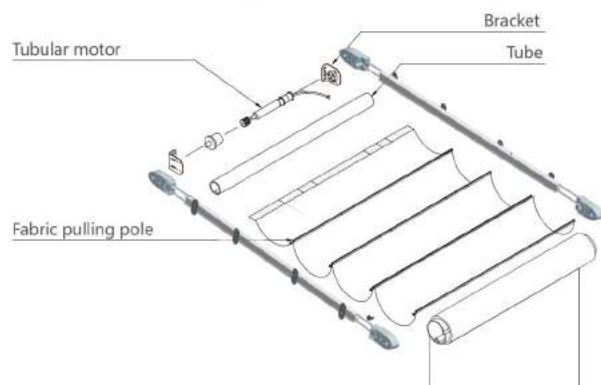

2 Step Skylight Shade

Motorized Projection Screen



Projection Screen is one of the most common equipment among projector's peripheral equipment, a suitable projection screen and a projector can produce excellent projection. Along with more and more people accepting the products, the Projection technology is gradually mature, so the projection system is popular in many fields such as family, education, government and commerce. It has promising future and will bring people more comfortable and convenient in life and working.



Projection screen



Cable



Radio



Center control

4:3

16:9

Accurate range limit function
Remote control function

Mute design
Fit for 16:9 and 4:3 screen



Invisible design: saving space, you can roll back the screen when don't use it.



Before invisibility



After invisibility



Motorized venetian blind

creating perfect household

E24 Motorized Venetian Blind



1. Adopt series Venetian blind motor, low noise, inbuilt brake, can prevent the problem of sliding because of overweight . One full set of Venetian blind with unique structure of localizer, making different specification products can locate up and down accurately , and position can be adjusted at will, accurate position .
2. Leaves specifications: 16mm / 25mm.
- 3, A variety of colors and colored insert blade to choose for the head rail.
4. Compatible with all the Venetian blind control system.



Venetian blind



Cable



Radio



Center control

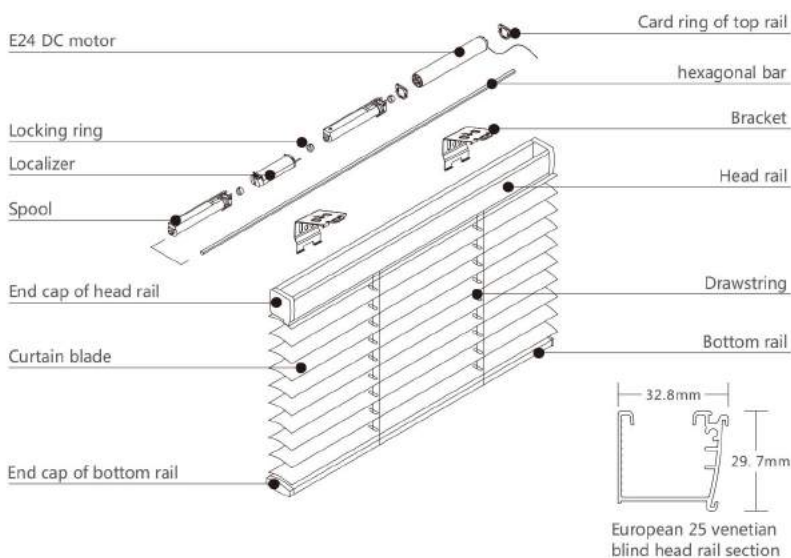

E24 Venetian Blind organization chart

35mm Motorized Venetian Blind



1. Venetian blinds motor with low noise, built-in brake to prevent overweight decline. Venetian blinds suit with a unique structure of Novo blinds localize, also have built-in series louver motor. So that the different specifications of the products can be accurately positioned up and down, and the position freely adjustable, precise positioning.
2. Slot match color by itself.
3. Compatible with all control system.

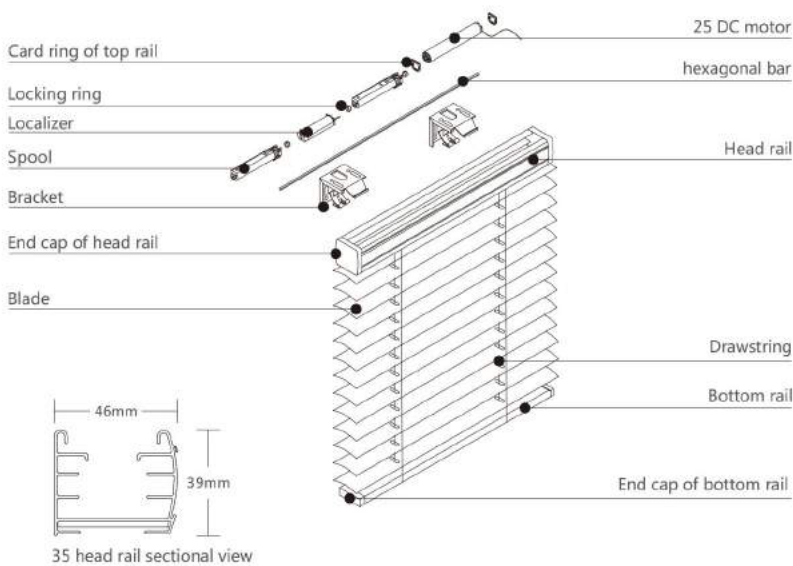

35mm Venetian Blind structure chart

Motorized Light Roman Blind



1. Adopt E24 Venetian blind system , low noise, easy and simple to install, no special requirements for the environment etc.
2. The complete set of system run smoothly .
3. Especially suitable for all sorts of small window.
4. Compatible with all control system.



Light roman blind



Cable



Radio



Center control

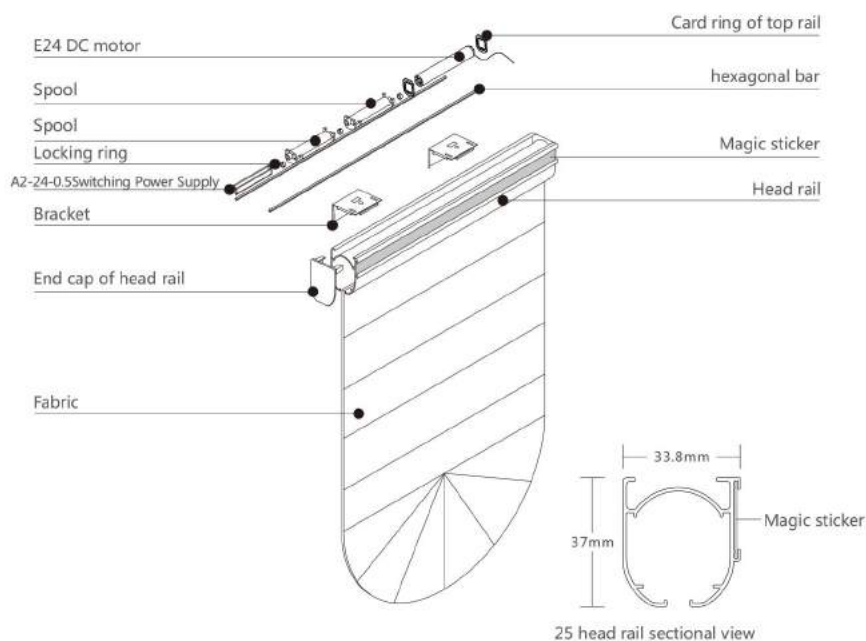

Light Roman Blind structure chart



Remote control system

creating perfect household

REMOTE CONTROL SYSTEM SOLUTION

Remote Control System can perfectly match with all kinds of motors, realize many control method. They can provide open and close function for Curtain Motor, Venetian Blind Motor and Tubular Motor, at the same time they can realize remote monitoring in single control and group control. This remote control system adopt 868MHz as radio frequency (innovate in this industry), it has the features of good antijamming capability, high receiving sensitivity, good frequency stabilization and easy debugging. The professional research and development team can customize the special remote control system according to the clients' different requirements.



Mhz868 is upgrade products of Mhz343

A6 channel transmitter

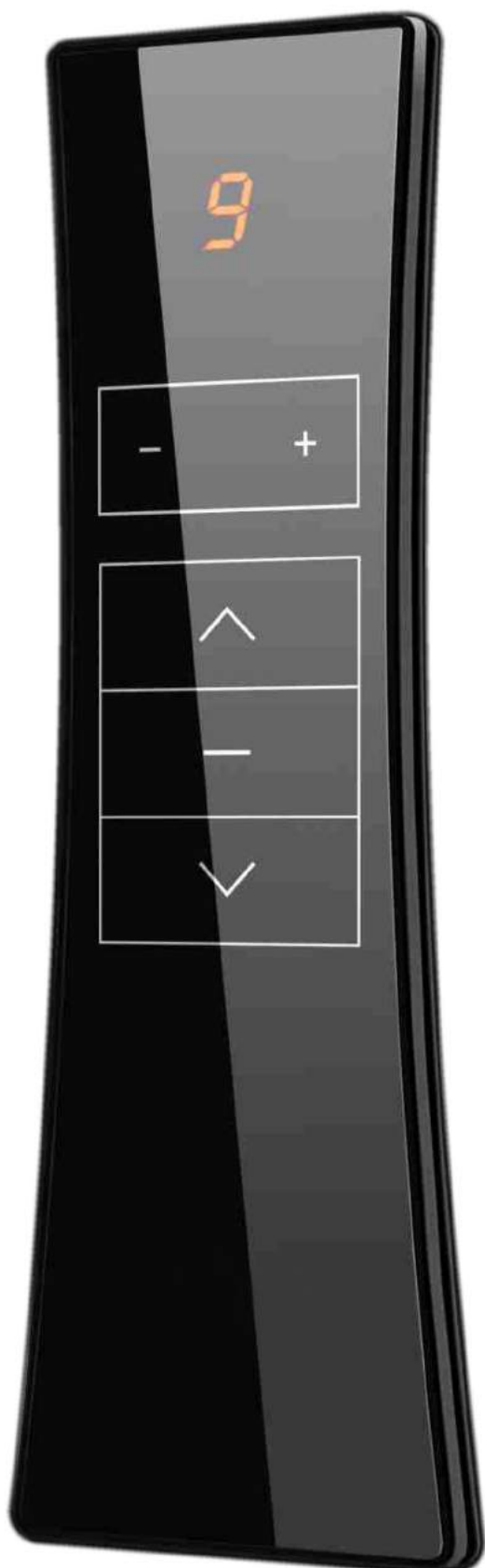

C individuality Publicity

L Free lock channel

C LED display

B Maximum 99 channel

S Efficient 868MHZ frequency of high sensitivity

S close feeling Process

Selective color



Dazzle black



White



Function Features:

It adopt 868MHz radio frequency(industry innovation)with a strong anti-jamming capability,high transmit sensitivity, and long distance transmit etc function.

Surface imported acrylic panel, smooth operation, intimate feel processes.

Interpretation of item

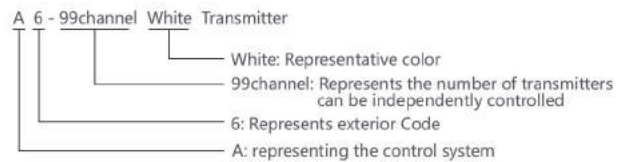
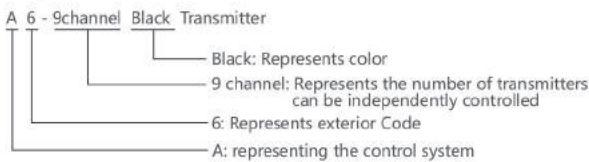

Item NO	Item	Battery Specifications	The frequency (MHz)	Working temperature	working humidity	Protection grade (IP)
D31020	A6-9 channel transmitter (black)	7#×2	868	-20°C~+65°C	≤90%	IP 40
D31021	A6-99 channel transmitter (black)	7#×2	868	-20°C~+65°C	≤90%	IP 40
D31022	A6-9 channel transmitter (white)	7#×2	868	-20°C~+65°C	≤90%	IP 40
D31023	A6-99 channel transmitter (white)	7#×2	868	-20°C~+65°C	≤90%	IP 40

A3 channel transmitter

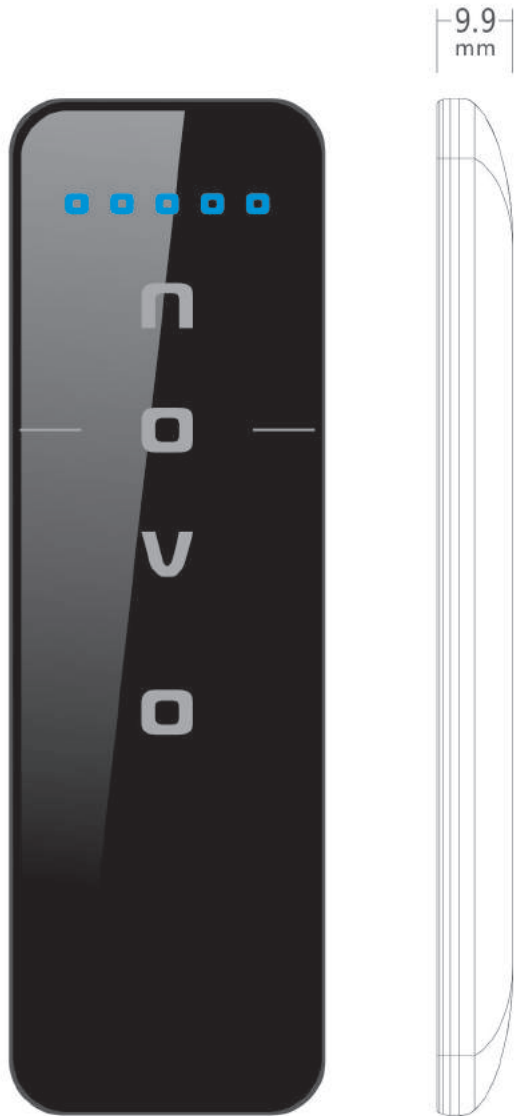

- T** Ultrathin design, the thickness is only 9.9mm
- F** The flat-panel, smooth surface, high hardness
- T** Touch screen, the fashion trend
- J** Jogging move and continuous move control individually
- S** 868MHz radio frequency has high sensitivity
- F** Withdraw battery box, no screw design make you change the battery fast

Selective color

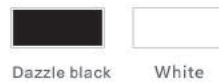

channel configuration: single channel two channel five channel

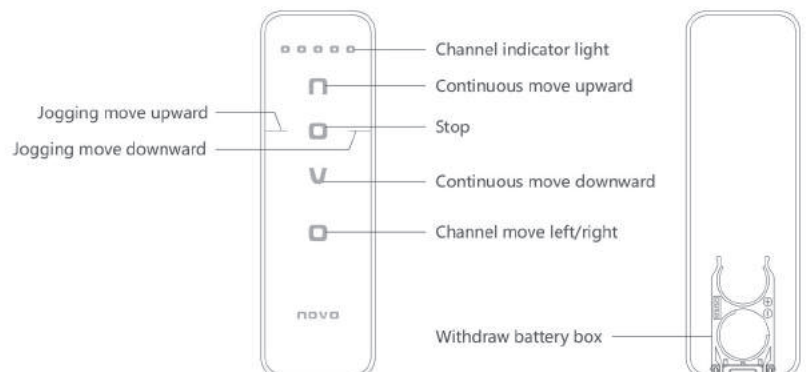
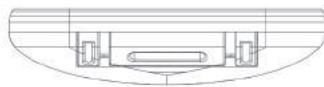

A3touch screen launcher



D30910

A3-1channel transmitter (black)



D30981

A3-2channel transmitter (black)



D30911

A3-5channel transmitter (black)

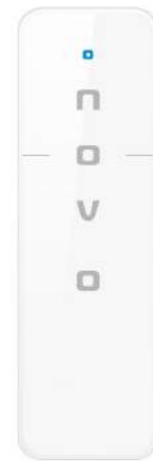

D30912

A3-1channel transmitter (white)

Function Features:

868MHz radio frequency (innovate in this industry),

It has the features of good antijamming capability, high receiving sensitivity, good frequency stabilization and easy debugging.

All imported components

Smooth surface, high hardness, aging resistance, strong adaptability to the natural environment, Safe to use indoor and outdoor

Touch screen button.

It has up,down,stop,continuous move, inching move function

Interpretation of item

A 3 - 1channel black Transmitter

black : Represents color

1channel: Represents the number of transmitters can be independently controlled

3 : Represents exterior Code

A : representing the control system



D30982

A3-2channel transmitter (white)



D30913

A3-5channel transmitter (white)

Item NO	Item	Battery Specifications	The frequency (MHz)	Working temperature	working humidity	Protection grade (IP)
D30910	A3-1channel transmitter (black)	button batteries×2	868	-20°C~+60°C	≤90%	IP 40
D30911	A3-5channel transmitter (black)	button batteries×2	868	-20°C~+60°C	≤90%	IP 40
D30912	A3-1channel transmitter (white)	button batteries×2	868	-20°C~+60°C	≤90%	IP 40
D30913	A3-5channel transmitter (white)	button batteries×2	868	-20°C~+60°C	≤90%	IP 40
D30981	A3-2channel transmitter (black)	button batteries×2	868	-20°C~+60°C	≤90%	IP 40
D30982	A3-2channel transmitter (white)	button batteries×2	868	-20°C~+60°C	≤90%	IP 40

A3button key transmitters



D32006

A3-1channel transmitter (black)



D32005

A3-2channel transmitter (black)



D32004

A3-5channel transmitter (black)



D32009

A3-1channel transmitter (white)

Function Features:

868MHz radio frequency (innovate in this industry),

It has the features of good antijamming capability, high receiving sensitivity, good frequency stabilization and easy debugging.

All imported components

Smooth surface, high hardness, aging resistance, strong adaptability to the natural environment, Safe to use indoor and outdoor

It has up,down,stop,continuous move, inching move function

Interpretation of item

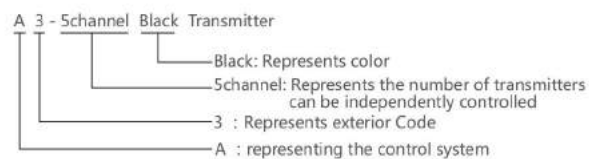

D32008

A3-2channel transmitter (white)



D32007

A3-5channel transmitter (white)

Item NO	Item	Battery Specifications	The frequency (MHz)	Working temperature	working humidity	Protection grade (IP)
D32004	A3-5 channel transmitter (black)	button batteries×2	868	-20°C~+60°C	≤90%	IP 40
D32005	A3-2 channel transmitter (black)	button batteries×2	868	-20°C~+60°C	≤90%	IP 40
D32006	A3-1 channel transmitter (black)	button batteries×2	868	-20°C~+60°C	≤90%	IP 40
D32007	A3-5 channel transmitter (white)	button batteries×2	868	-20°C~+60°C	≤90%	IP 40
D32008	A3-2 channel transmitter (white)	button batteries×2	868	-20°C~+60°C	≤90%	IP 40
D32009	A3-1 channel transmitter (white)	button batteries×2	868	-20°C~+60°C	≤90%	IP 40

A10 Button Transmitter

New design with comfortable cambered bottom





A10 button transmitter

Function Features:

A10 button transmitter use 868MHz radio frequency(industry innovation)with a strong anti-jamming capability, high transmit sensitivity,and long distance transmit etc function. Surface imported acrylic panel, smooth operation, intimate feel processes.

Interpretation of item

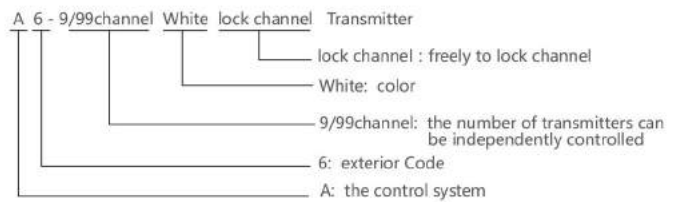
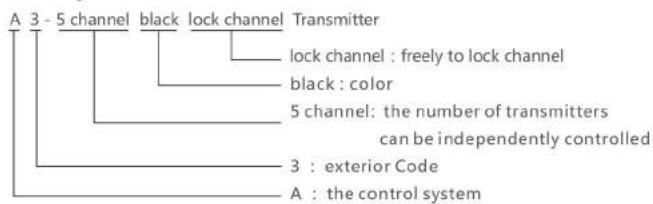

Item NO.	Item	Battery Specifications	The frequency (MHz)	Working temperature	Protection grade (IP)
D32042	A10-5 channel white locking transmitter	7#x2	868	-20°C~+60°C	IP 40

A2 channel transmitter



D30902

A2-12 channel transmitter

Display screen:	LCD screen
Function Features:	Single control, group control (12 channels) Display the signal strength
Power Supply:	3V (AAA battery 1.5Vx2)
Transmitting frequency:	868MHz
Transmitting power:	10mW
Protection class:	IP 40
Effective range:	Outdoor view distance is 200 meters, indoor concrete wall is 30 meters
Working temperature:	-20°C ~ +60°C



Remarks: Only the channel which is programmed successfully can be controlled

Single control



Single channel is selected
(channel select)

Group control



12 Channels are selected
(channel select)

Function Features:

868MHz radio frequency (innovate in this industry),
It has the features of good antijamming capability,
high receiving sensitivity, good frequency
stabilization and easy debugging.
Long service life.
All imported components
Upward, downward, stop, jogging move function.

A3 channel free stick-on transmitter

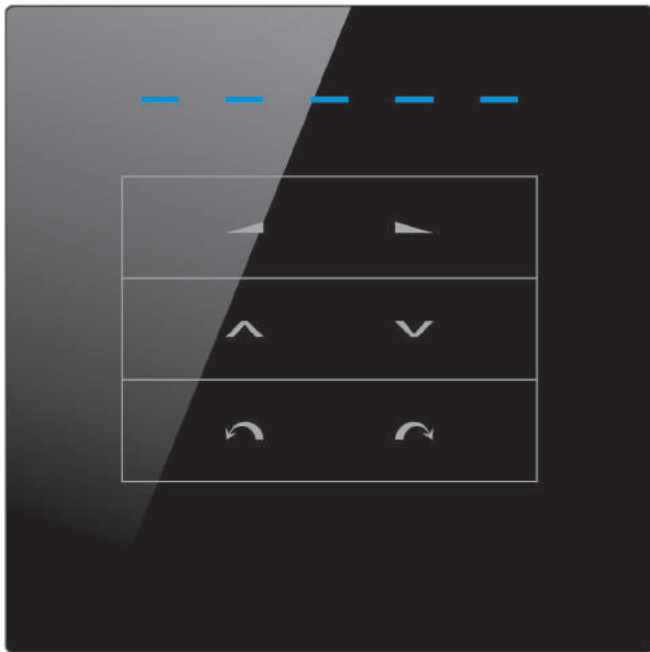

- F** The flat-panel, smooth surface, high hardness
- T** Touch screen, the fashion trend
- J** Jogging move and continuous move control individually
- S** 868MHz radio frequency has high sensitivity
- C** Powerful magnet in back, stick to the wall conveniently

Selective color



Dazzle black White

channel configuration: single channel two channel five channel

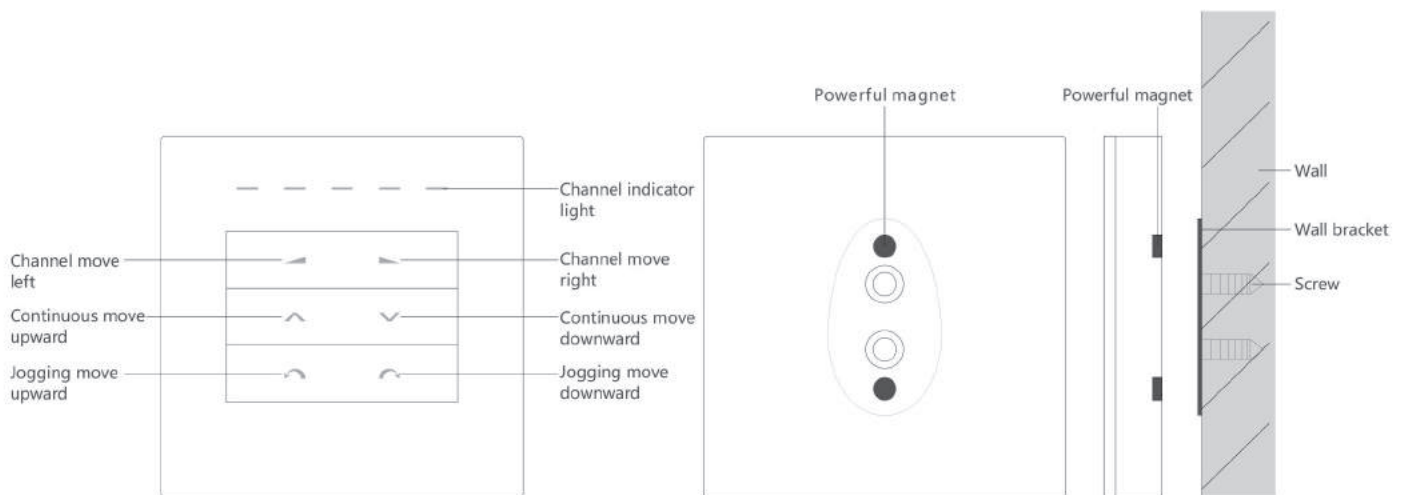

Remarks: 1.press any key to stop 2.press any key the channel indicator light turned on.

A3 Free stick-on transmitter



SD30928

A3-1 channel free stick-on transmitter

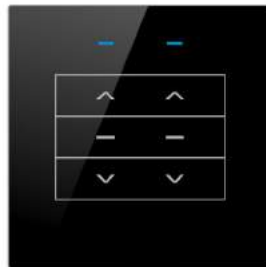

SD30929

A3-2 channel free stick-on transmitter

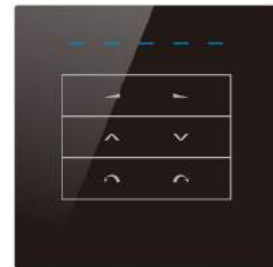

D30930

A3-5 channel free stick-on transmitter



SD30931

A3-1 channel free stick-on transmitter (white)



SD30932

A3-2 channel free stick-on transmitter (white)



D30933

A3-5 channel free stick-on transmitter (white)

Function Features:

868MHz radio frequency (innovate in this industry),

It has the features of good antijamming capability, high receiving sensitivity, good frequency stabilization and easy debugging.

All imported components

Smooth surface, high hardness, aging resistance, strong adaptability to the natural environment, Safe to use indoor and outdoor

Touch screen button.

It has up,down,stop,continuous move, inching move function

Interpretation of item

A 3 - 1channel free stick-on transmitter

1 channel: Represents the number of transmitters can be independently controlled

3 : Represents exterior Code

A : representing the control system

Item NO	Item	Battery Specifications	The frequency (MHz)	Working temperature	working humidity	Protection grade (IP)
SD30928	A3-1 channel transmitter (black)	button batteries×2	868	-20°C~+60°C	≤90%	IP 40
SD30929	A3-2 channel transmitter (black)	button batteries×2	868	-20°C~+60°C	≤90%	IP 40
D30930	A3-5 channel transmitter (black)	button batteries×2	868	-20°C~+60°C	≤90%	IP 40
SD30931	A3-1 channel transmitter (white)	button batteries×2	868	-20°C~+60°C	≤90%	IP 40
SD30932	A3-2 channel transmitter (white)	button batteries×2	868	-20°C~+60°C	≤90%	IP 40
D30933	A3-5 channel transmitter (white)	button batteries×2	868	-20°C~+60°C	≤90%	IP 40

A4 Stick-on Transmitter



D30948
A4-1Stick-on Transmitter



D30947
A4-5Stick-on Transmitter



D30949
A4-2Stick-on Transmitter

Function Features:

868MHz radio frequency (innovate in this industry), It has the features of good antijamming capability, high receiving sensitivity, good frequency stabilization and easy debugging.

All imported components

The smooth surface, high hardness, excellent resistance to aging, the natural environment adaptability, indoor and outdoor can be safe to use.

push-button switch

Up button/ down button/ stop button,

Continue and stop moving function.

Interpretation of item

A 4 - 1channel Stick-on Transmitter

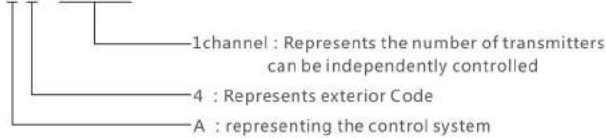

A 4 - 5channel Stick-on Transmitter

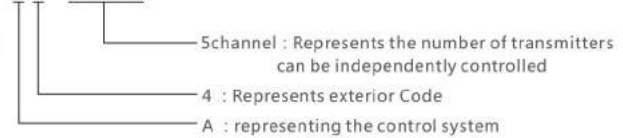

Item NO	Item	Battery Specifications	The frequency (MHz)	Working temperature	working humidity	Protection grade (IP)
D30947	A4-1Stick-on Transmitter	button batteries×2	868	-20°C~+60°C	≤90%	IP 40
D30948	A4-2Stick-on Transmitter	button batteries×2	868	-20°C~+60°C	≤90%	IP 40
D30949	A4-5Stick-on Transmitter	button batteries×2	868	-20°C~+60°C	≤90%	IP 40

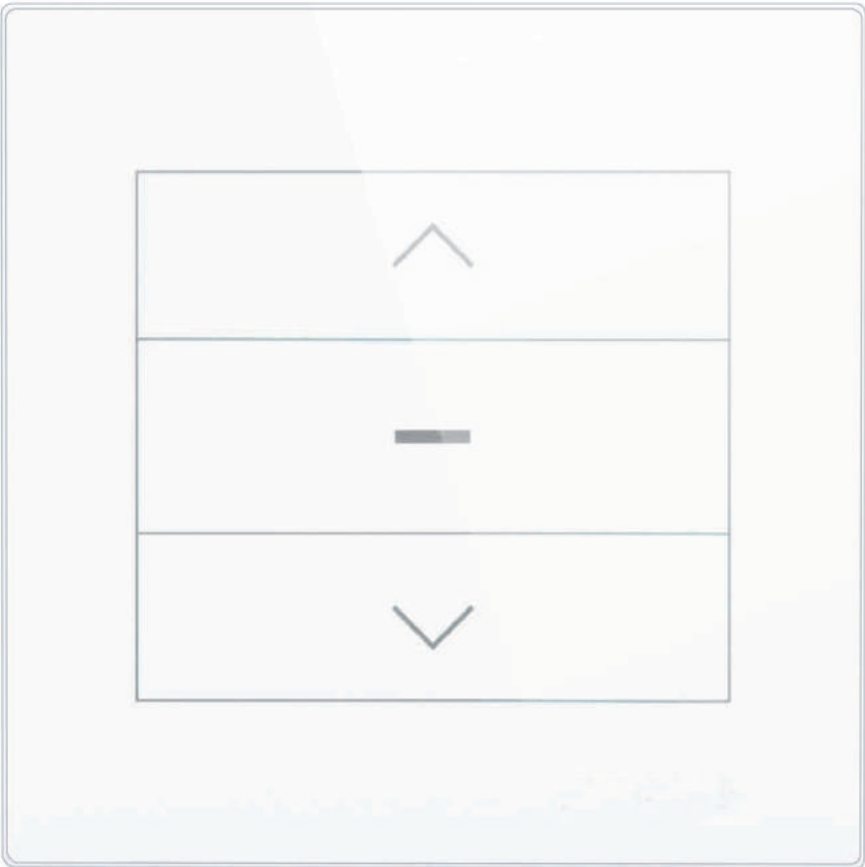

- F** The flat-panel, smooth surface, high hardness
- T** Touch screen, the fashion trend
- J** Jogging move and continuous move control individually
- S** 433MHz radio frequency has high sensitivity

Selective color



White

A7 touch Screen receiver (80mmx80mm European standard bottom box)



D33011

A 7 single channel 110-240 Receiver (white)

Input voltage: 100V-240V
 Output voltage: 100V-240V
 Bottom case: standard wall
 European standard bottom case
 Size: 80x80mm
 Working temperature: -20°C ~ +60°C

Function Features:

868MHz radio frequency (innovate in this industry),

It has the features of good antijamming capability, high receiving sensitivity, good frequency ,stabilization and easy debugging.

All imported components

Smooth surface, high hardness, aging resistance, strong adaptability to the natural environment, Safe to use indoor and outdoor
 Touch screen button.

It has up,down,stop,continuous move, inching move function

It has wireless receive and wire control function

Can match with any styles of transmitter.

Installation bottom case using European standards bottom case

Interpretation of item

A 7 Single 110-240 White Receiver

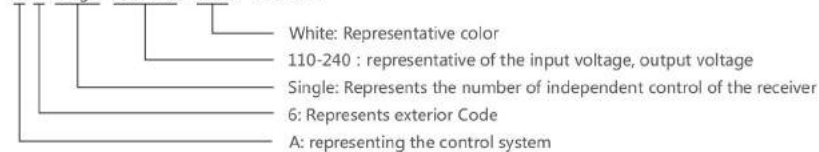

Item NO	Item	Input voltage (V)	Output voltage (V)	Power (w)	size	Working temperature
D33011	A7 single channel 110-240 Receiver (white)	110V~240V	110V~240V	400W	80x80mm	-20°C~+60°C

A9 AC Button Receiver



A9 single channel receiver



A9 double channel receiver



A9-1 channel receiver back



A9 receiver side

Interpretation of item

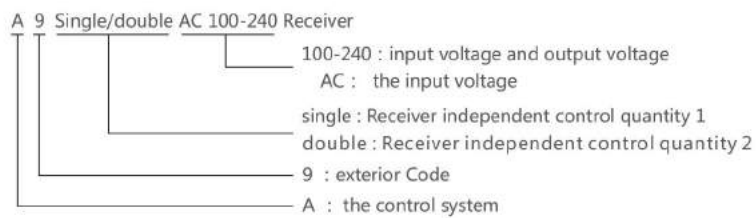

Item NO.	Item	Input voltage (V)	Output voltage (V)	Power (w)	size	Working temperature
D33072	A9 single channel AC100-240 receiver	AC100-240	AC100-240	400	86x86mm	-20°C~+60°C
D33073	A9 double channel AC100-240 receiver	AC100-240	AC100-240	400x2	86x86mm	-20°C~+60°C

A4 Receiver



D30937

A4 single-channel AC-24 receivers



D30938

A4 double channel AC-24 receivers



D30939

A4 single-channel 220 receivers



D30940

A4 double channel 220 receivers

Function Features:

868MHz radio frequency (innovate in this industry), It has the features of good antijamming capability, high receiving sensitivity, good frequency stabilization and easy debugging.

All imported components

The smooth surface, high hardness, excellent resistance to aging, the natural environment adaptability, indoor and outdoor can be safe to use
Wall embedded.

Up button/ down button/ stop button.

Continue and stop moving function.

Can match with any styles of transmitter.

Interpretation of item

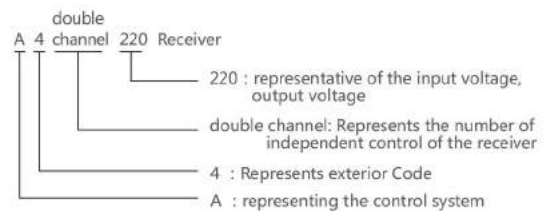
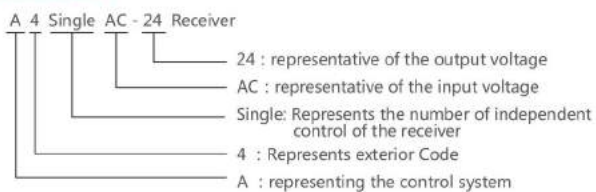

Item NO	Item	Input voltage (V)	Output voltage (V)	Power (w)	size	Working temperature
D30937	A4 single-channel AC-24 receivers	90V~240V	24V	12W	86x86mm	-20°C~+60°C
D30938	A4 double channel AC-24 receivers	90V~240V	24V	12W	86x86mm	-20°C~+60°C
D30939	A4 single-channel 220 receivers	110V/220V	110V/220V	220W	86x86mm	-20°C~+60°C
D30940	A4 double channel 220 receivers	110V/220V	110V/220V	220W	86x86mm	-20°C~+60°C



SD30920
A3 single-channel 100-240 receivers



SD30921
A3 double channel 100-240 receivers

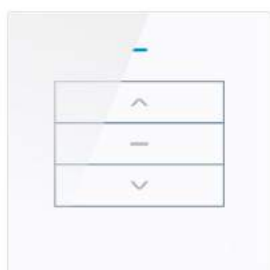

SD30922
A3 single-channel 100-240 receivers



SD30923
A3 double channel 100-240 receivers

Interpretation of item

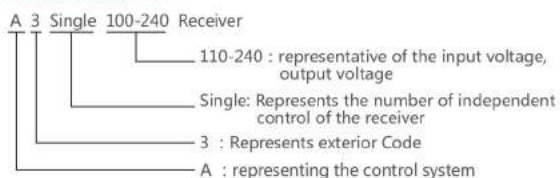

Function Features:

868MHz radio frequency (innovate in this industry), It has the features of good antijamming capability, high receiving sensitivity, good frequency stabilization and easy debugging.

All imported components

The smooth surface, high hardness, excellent resistance to aging, the natural environment adaptability, indoor and outdoor can be safe to use
Wall embedded.

Touch screen button.

Upward, downward, stop, continuous move, jogging move function.

Can match with any styles of transmitter.

Item NO	Item	Input voltage (V)	Output voltage (V)	Power (w)	size	Working temperature
SD30920	A3 single-channel 100-240 receivers	90V~240V	90V~240V	400W	86x86mm	-20°C~+60°C
SD30921	A3 double channel 100-240 receivers	90V~240V	90V~240V	400W×2	86x86mm	-20°C~+60°C
SD30922	A3 single-channel 100-240 receivers	90V~240V	90V~240V	400W	86x86mm	-20°C~+60°C
SD30923	A3 double channel 100-240 receivers	90V~240V	90V~240V	400W×2	86x86mm	-20°C~+60°C

A3 Receiver

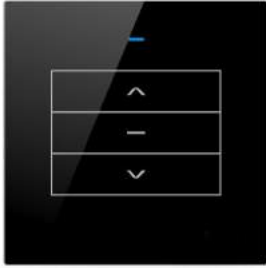

SD30924

A3 single-channel AC-24 receivers



SD30925

A3 double channel AC-24receivers

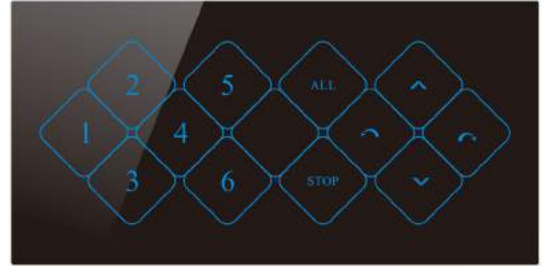

D33042

A3six channel AC-24 receivers (black)



SD30926

A3 single-channel AC-24 receivers



SD30927

A3 double channel AC-24receivers

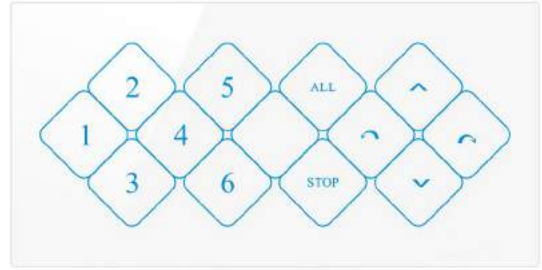

D33043

A3 six channel AC-24 receivers (white)

Interpretation of item

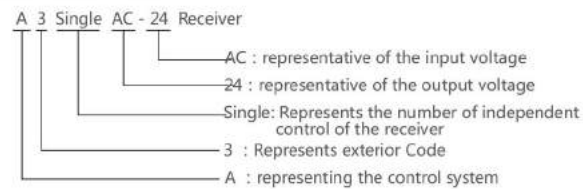

Function Features:

868MHz radio frequency (innovate in this industry), It has the features of good antijamming capability, high receiving sensitivity, good frequency stabilization and easy debugging.

All imported components

The smooth surface, high hardness, excellent resistance to aging, the natural environment adaptability, indoor and outdoor can be safe to use

Wall embedded.

Touch screen button.

Upward, downward, stop, continuous move, jogging move function.

Can match with any styles of transmitter.

Item NO	Item	Input voltage (V)	Output voltage (V)	Power (w)	size	Working temperature
SD30924	A3 single-channel AC-24 receivers	90V~240V	12V/24V	12	86x86mm	-20°C~+60°C
SD30925	A3double channel AC-24receivers	90V~240V	12V/24V	12	86x86mm	-20°C~+60°C
SD30926	A3 single-channel AC-24 receivers	90V~240V	12V/24V	12	86x86mm	-20°C~+60°C
SD30927	A3 double channel AC-24receivers	90V~240V	12V/24V	12	86x86mm	-20°C~+60°C
D33042	A3 six channel AC-24 receivers (black)	90V~240V	12V/24V	12	172x86mm	-20°C~+60°C
D33043	A3 six channel AC-24 receivers (white)	90V~240V	12V/24V	12	172x86mm	-20°C~+60°C

ACCESSORIES SYSTEM

accessories are the assistant components which can be perfectly matched with all kinds of motors, all of them using high quality materials can meet different kinds of clients' requirements.



Dozens of automatic processing equipment with high efficiency, high precision, high reliability, can customize all kinds of products according to clients' requirements.



N10321
N09 drive unit 1N
with fabric hanger



N10322
N09 drive unit 2N
with fabric hanger



N10323
N09 drive unit
with fabric hanger



N10331
N09 loop stop
stainless steel



N10211
N09 track joiner



N10311
carrier -without arm (steel)



N10312
carrier -with arm (steel)



N30165
N09 track 90 degree bend



N10405
N09 curtain track
lacquer inside-out DS-1
micky white



N10306
belt -imported



N10307
belt - jointed
venture



D21604
drapery bracket



D21601
L bracket (single track)



D21603
L bracket (double track)



N10305
N08 Runner
stainless steel ring

Roller Blind Accessories (1)



D26110
Φ50 Idler(round)
injection molding



D26111
Φ65 round idler
injection molding



D26115
Φ50 Idler(round)
with spring



D26116
Φ65 round idler
with spring



D26117
Φ50 Idler(square)
with spring



D26118
Φ65 Idle(square)
with spring



D20401
Φ40 Idler (square axle)
Nylon + bearing



D20402
Φ50 Idler (square axle)
Nylon + bearing



D20403
Φ65 Idler (square axle)
Nylon + bearing



D20404
Φ90 Idler (square axle)
Nylon + bearing



D20201
Φ40 middle bracket
square Axle + Nylon



D26060
Φ50 middle bracket
cinquefoil axle+ nylon



D26061
Φ50 middle bracket(adjustable)
cinquefoil axle+ nylon



D26070
Φ65 middle bracket
cinquefoil axle+ nylon



D26071
Φ65 middle bracket (adjustable)
cinquefoil axle+ nylon



D26080
Φ50 intermediate bracket(lengthen)
cinquefoil axle+ nylon



D26090
Φ65 intermediate bracket(lengthen)
cinquefoil axle+ nylon



D26096
Φ90 intermediate bracket(lengthen)
square axle+ nylon



D26121
Φ50-90 axle
square axle + nylon



D26122
Φ50-135 axle
square axle + nylon



D26123
Φ65-90 axle
square axle + nylon



D26124
Φ65-135 axle
square axle + nylon



D26125
Φ50-90 axle (lengthen)
square axle + nylon



D26126
Φ50-135 axle (lengthen)
square axle + nylon





D26127 
 Φ65-90 axle (lengthen)
 square axle +nylon



D26128 
 Φ65-135 axle (lengthen)
 square axle +nylon



D26129 
 Φ90-90 axle (lengthen)
 square axle +nylon



D26130 
 Φ90-135 axle (lengthen)
 square axle +nylon



D26310 
 Φ50 middle bracket
 square axle +nylon



D26320 
 Φ50 middle bracket (lengthen)
 square axle +nylon



D26330 
 Φ65 middle bracke
 square axle +nylon



D26340 
 Φ65 middle bracket (lengthen)
 square axle +nylon



D26010
 Motor bracket
 Include cinquefoil head



D26011
 Idler bracket(square hole)
 match square shaft



D26020
 Idler bracket(square axle)
 Not include idler



D26021
 Idler bracket(square axle strengthen)
 Not include idler



D26030
 Idler bracket(round axle)
 Not include idler



D26040
 Motor bracket(lengthen)
 Include cinquefoil head



D26041
 Motor bracket(square hole lengthen)
 match square shaft



D26050
 Idler bracket(square axle lengthen)
 Not include idler



D26051
 Idler bracket(square axle lengthen
 and strengthen) Not include idler



D26210
 Somfy motor bracket
 Include cinquefoil head



D26211
 Somfy motor bracket (lengthen)
 Include cinquefoil head



D20502
 Φ40 adapt wheel(cinquefoil)
 Injection mould with imported nylon



D20504
 Φ50 adapt wheel(cinquefoil)
 match 50mm tubular motor



D20506
 Φ65adapt wheel(cinquefoil)
 Injection mould with imported nylon

















D20509 
 Φ90 adapt wheel(cinquefoil)
 imported nylon



D20603
 Φ40 crown
 Injection mould with imported nylon

Roller Blind Accessories (3)

 <p>D20606 Φ65 crown Injection mould with imported nylon</p>	 <p>D20607  Φ90-50 crown Machinofacture with imported nylon</p>	 <p>D20608  Φ90-60 crown Machinofacture with imported nylon</p>	 <p>D60102 Φ40tube Frosted surface</p>
 <p>D60103 Φ50tube Frosted surface</p>	 <p>D60104 Φ65tube Frosted surface</p>	 <p>D60105 Φ90tube Frosted surface</p>	 <p>D60308 roller blind cover(top cover) for roller blind</p>
 <p>D60309 roller blind cover(bottom cover) for roller blind</p>	 <p>D21610 roller blind cover bracket(left and right) include cinquefoil and hitching leg</p>	 <p>D21611 roller blind cover bracket(left and right) include 2 idler hitching leg</p>	 <p>D21613 Motorized roller blind cover bracket (left and right) Include NOVO cinquefoil and idle hitching leg</p>
 <p>D21612 roller blind cover bracket Aluminum</p>	 <p>D60201 Heavy bottom rail</p>	 <p>D21309 Rubber strip for bottom rail</p>	 <p>D21307 end cap for heavy bottom rail</p>
 <p>D21308 end cap for light bottom rail</p>	 <p>D60202 light bottom rail</p>	 <p>D21310 guiding sealing stainless steel 304</p>	 <p>D21311 guiding foundation stainless steel 304</p>
 <p>D20610 38adapt wheel</p>	 <p>D20611 38crown</p>	 <p>D20612 38 idler bracket</p>	 <p>D20613 38 motor bracket</p>
 <p>D22220 Joiner for pull bar 100*Φ9 (M4.0)</p>	 <p>D22221 Drawstring locking bar for pull bar 40*Φ7 (M4.0)</p>	 <p>D20614 K25-38 idler</p>	

Venetian Blind Accessories (1)



D21103

Φ35mm honeycomb blind bracket



D21121

The European style 25mm Venetian blind bracket



D21205

Φ50mm Venetian blind bracket(square)



D21207

Φ50mm Venetian blind middle bracket



D21206

Φ50mm Venetian blind bracket(length)



D21298/D21299

European Style 35mm honeycomb blind head rail cap left /right (white)



D21312/D21313

European Style 25mm Venetian blind head rail cap left /right (white)



D21314/D21315

European Style 25mm Venetian blind head rail cap left /right (white)

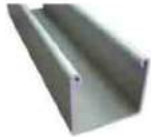

D60302

Φ50mm Venetian blind head rail



D60303

European style 35mm honeycomb blind head rail insert slat to match color (white)



D60531

European style 25mm Venetian blind head rail insert slat to match color (white)



D60532

European style 25mm honey comb head rail insert slat to match color (white)



D21201

Φ50mm Venetian blind spool



D21202

Φ50mm venetian blind spool bracket



D21203

Φ50mm Venetian blind spool bracket



D21204

Φ50mm Venetian blind motor bracket



D21809

2.5mm Venetian blind ladder lock for 25mm Venetian blind motor



D21810

5.0mm Venetian blind ladder rope lock



D21907

Φ1.4mm cord (multicolor can be chose) for motorized Venetian blind



D21908

Φ2.0mm tape for roman blind



D60301

Φ40 octangle tube



D60405

hexagon stick (6.0mm) 3.4M/pc



D20406

Φ40 octangle Idler Nylon + stainless steel axle



D20511

Φ40 octangle adapt wheel (cinquefoil) Injection mould with imported nylon

Venetian Blind Accessories (2)

 Customizable



D20601

Φ40 octangle crown
Injection mould with imported nylon



D21101

Φ25mm Venetian blind spool



D22101

Φ25mm Venetian blind head rail punch



D22102

Φ50mm Venetian blind head rail punch



D21104

Roman blind head rail bracket



D21105

Roman blind spool



D21106

Roman blind head rail cap
white



D60601

Roman blind head rail (light-duty)
white

A20-4 Channel Group Controller Operating Manual

Company reserves the right to change product design and specifications without prior notice then, photos are for reference only.

P Product parameters

Item NO.	Item	Input voltage (V)	Output voltage (V)	Power (w)	Size	Working temperature
D30703	A20-4 Channel Group Controller	AC110	AC110	300x4	94x61mm	-20°C~+60°C
D30701	A20-4 Channel Group Controller	AC220	AC220	300x4	94x61mm	-20°C~+60°C

Features :

- Made by first-line international brands relay (5A)
- Each channel has an independent cutout, total 4 pcs cutouts
- Each interface uses pop-up terminal interface
- Made with German Bayer PC material, withstand high temperature, anti-aging size



Size: 94x61x47mm

W Wiring diagram

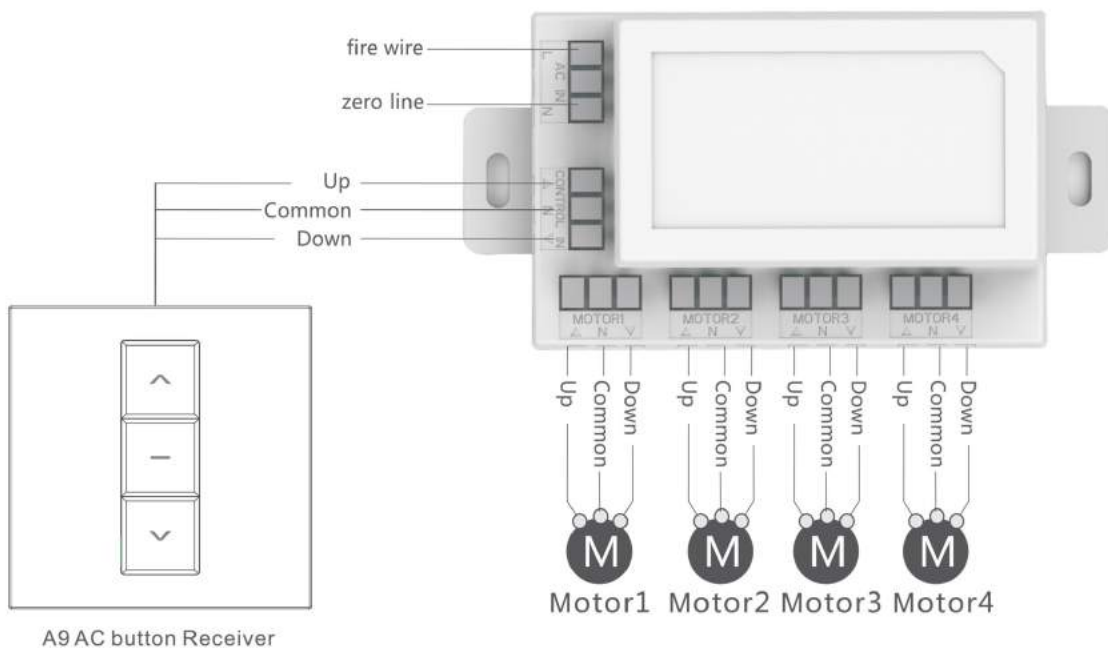



ELECTRIC DRYING RACK



ELECTRIC DRYING RACK

ราวตากผ้าไฟฟ้าเรียกได้ว่าเป็นหนึ่งในเครื่องใช้ในครัวเรือนอันชาญฉลาด ณ ตอนนีซึ่งใช้กลไกขับเคลื่อนพลังงานด้วยมอเตอร์ ตัวของราวตากผ้าไฟฟ้านี้ ประกอบด้วยตัวราวหลัก ระบบควบคุมพลังงาน ระบบยก และระบบทำแห้ง

หน้าที่พื้นฐานหลักของตัวชุดอุปกรณ์นี้คือ การทำให้เสื้อผ้าแห้ง ด้วยวิธีที่เหนือกว่า ฉลาดกว่า ราวตากผ้าทั่วไป ซึ่งสามารถติดตั้งง่าๆ ในคอนโด หมู่บ้าน อพาร์ทเมนท์ ชุดอาคารอิสระ หรือในดึกทั่วๆ ไปตามที่กล่าวมานี้ ชุดอุปกรณ์ราวตากผ้าไฟฟ้านี้มีข้อได้เปรียบอันหลากหลาย อาทิเช่น มีความแข็งแรงคงทนของตัว โครงสร้างราวสูง สามารถรับน้ำหนักได้มาก ระบบการยกขึ้น ลงราบลื่น ไม่สะดุด ภายในประกอบด้วยระบบป้องกันการรับน้ำหนักเกิน และระบบป้องกันสิ่งกีดขวางซึ่งสามารถป้องกันมอเตอร์ ได้อย่างเต็มที่ อีกทั้งยังยึดอายุการใช้งานที่ยาวนานกว่าและมีการยกระดับด้านความปลอดภัยในการเดินสายไฟให้ดียิ่งขึ้น ชุดอุปกรณ์ราวตากผ้าไฟฟ้านี้ถือเป็นการปฏิวัติเทคโนโลยีใหม่ล่าสุด เพื่อให้ตอบสนองความต้องการของลูกค้าชั้นสูง ได้อย่างสมบูรณ์แบบ ชุดอุปกรณ์อันทันสมัย จะเป็นผู้ช่วยที่ดีให้กับทุกครัวเรือนได้อย่างแน่นอน



High quality PCB

- ผลิตภัณฑ์ที่มีคุณภาพและความทนทาน

Remote Control

- ผ่านการทดสอบการใช้งานมาแล้วมากกว่า 1 ล้านครั้ง ในระยะ 30 เมตร



ระบบการทำผ้าแห้ง Fan dry Function



Fast drying

ในสภาพอากาศฟ้าครึ้มฝนตก อาจเป็นสาเหตุทำให้ผ้าที่ตากไว้มีความชื้น เป็นเรื่องที่ค่อนข้างสร้างความลำบากมากเลยทีเดียว แต่ด้วยระบบการทำแห้งอันชาญฉลาดของชุดอุปกรณ์ราวตากผ้าไฟฟ้า ที่ติดตั้งพัดลมไว้ถึง 2 ตัว จะช่วยเป่าให้ผ้าที่ตากไว้แห้งอย่างง่ายดาย สามารถช่วยให้ผู้ใช้งานแก้ปัญหาผ้าแห้งไม่ทันได้อย่างง่ายดาย

ฆ่าเชื้อแบคทีเรีย UV disinfection



Sterilize

การตากผ้าในสภาพที่มีความชื้นบ่อยครั้ง หรือการผึ่งผ้าไม่แห้งพอ อาจเป็นสาเหตุการของการสะสมเชื้อแบคทีเรีย ราวตากผ้าอัจฉริยะนี้ สามารถช่วยป้องกันและยับยั้งการเกิดเชื้อราหรือแบคทีเรียได้ ด้วยความพิเศษของหลอด UV ที่ติดตั้งเป็นอุปกรณ์มาตรฐานมากับตัวเครื่อง จะช่วยให้ปัญหาดังกล่าวหมดไป

ไฟแสงสว่าง LED Lighting

LED

LED lighting

เพิ่มความสะดวกในการมองเห็นในตอนกลางคืน หรือช่วงเวลาที่มืดแสงน้อย ด้วยการติดตั้งไฟแอลอีดี เป็นชุดอุปกรณ์มาตรฐาน ให้ความสว่างชัดเจนและประหยัดไฟ เพิ่มความสะดวกสบายและสวยงาม

ควบคุมด้วยรีโมทไร้สาย



Remote Control

ระบบการยก ขึ้น-ลง ของราวตากผ้าอัตโนมัตินี้ง่ายต่อการใช้งาน ด้วยรีโมทคอนโทรลไร้สายมีมีฟังก์ชันการใช้งานให้เลือกใช้ตามความต้องการหรือความเหมาะสมต่อการใช้งาน และด้วยรีโมทคอนโทรล ยังสามารถสั่งการ ไฟแสงสว่าง ไฟUV รวมถึงพัดลมเป่าแห้ง หลากหลายฟังก์ชัน รวมถึงการตั้งเวลาการทำงานอัตโนมัติได้อีกด้วย

ทรูทราและใช้งานได้เยี่ยม ด้วยการควบคุมผ้าม่านแบบไร้สาย

สะดวกสบายแต่ปลายนิ้วสัมผัส

wise

ระบบควบคุมผ้าม่านไฟฟ้า
ราคาไม่แพงที่นี้ที่เดียว
จะรอช้าอยู่ทำไม รีบตัดสินใจ



Website	email	Tel.	ที่อยู่
www.wisecurtain.com	wisecurtain@hotmail.com	086-3418620 098-5156356 081-6030539	508/8 ถนนสุขุมวิท ตำบลปากน้ำ อำเภอเมืองสมุทรปราการ สมุทรปราการ 10270